

Earthquake Prediction at Home with Reverse Radio

Earthquake prediction information service

Earthquake prediction system
by detecting electromagnetic noise

<https://yurekurun.com/>

SERC

株式会社 新興技術研究所

SHINKO ENGINEERING RESEARCH CORP.
<http://www.shinko-japan.com>

Agent.

SERC SHINKO ENGINEERING RESEARCH CORP.

Reference of place names in the text

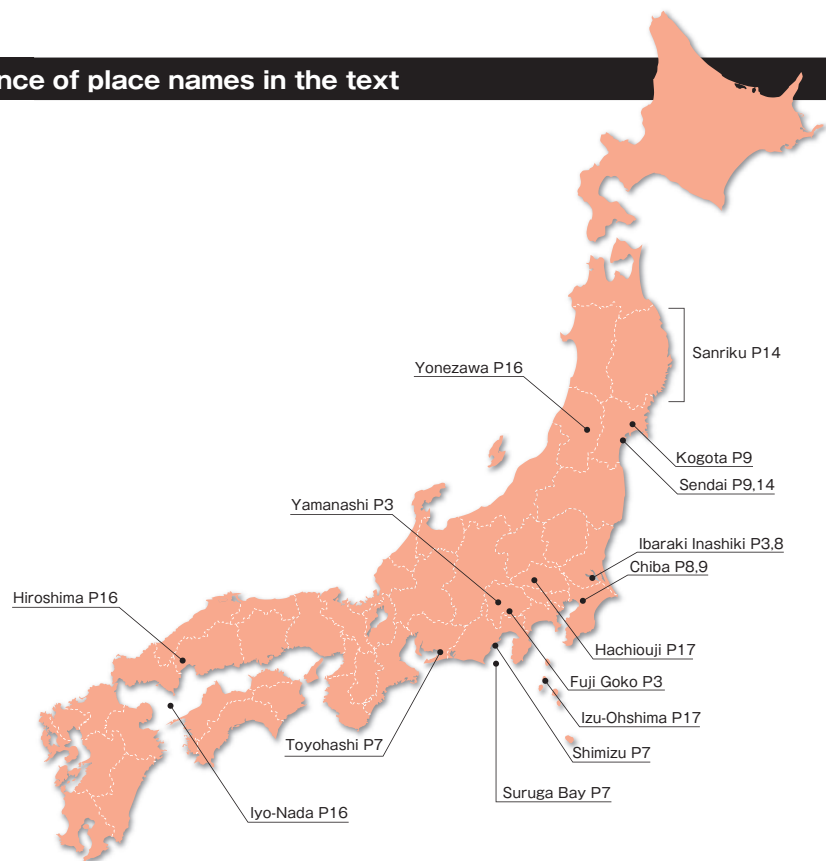

CONTENTS

Introduction 1

Research Based On Electric / Electromagnetic Approach to Earthquake Prediction 1

Sample Earthquake Prediction Based on Data Obtained from Reverse Radio 3

Earthquake Prediction Rate Using Data from Reverse Radio 4

Earthquake Prediction at Home : Observation System for Electromagnetic Radiation Noise Occurring in Nature Using Reverse Radio 6

Earthquake Prediction at Home 7

Using Abnormal Data Detection as the Method for Earthquake Prediction 8

Case Study of Earthquake Prediction 10

Detection Technique of Electromagnetic Radiation Noise Occurring in Nature Using Reverse Radio 14

Precursor of Great East Japan Earthquake 15

Practical Application of Prediction Information by Private Companies 15

Network of 3000 Observation Points Nation-wide 15

Earthquake Prediction : A Contribution to the World 15

Conclusion 16

Earthquake Prediction at Home with Reverse Radio

Takashi Kumagai, Chairman, Shinko Engineering and Research Corp.

Introduction

Although our core business is designing/developing production automation systems, we have come to recognize the importance of "earthquake prediction", which was one of the topics discussed at an inter-industry event our company hosted immediately after the Great Hanshin and Awaji Earthquake in January of 1995. We have thus begun exploring the possibility of earthquake prediction even though we were far from being an expert in seismology.

As a result of our research, we have found the article in "Nature" written by Mr. Fujinawa, a Research Officer at National Research Institute for Earth Science and Disaster Prevention, (*1) "Emission of Electromagnetic Radiation Preceding the Ito Seismic Swarm of 1989" and, with some fund raised by the group companies, began our own research on the earthquake prediction by detection of electromagnetic radiation noise, which would serve as a kind of precursor of earthquake.

In spite of the subsidy provided by Japan Science and Technology Corporation in 2000, the reality is that our endeavor has yet to be financially viable.

Nevertheless, we were able to send our members via e-mail "a major earthquake warning for Sendai region" more than a month prior to the Great East Japan Earthquake in 2011.

Research Based On Electric / Electromagnetic Approach to Earthquake Prediction

Japan's Ministry of Education, Culture, Sports, Science and Technology quashed its "earthquake prediction plan" after the 7th version as it declared that it was "impossible to predict earthquakes at this point". Instead, the ministry announced its new "plan to move forward with new observations and research for the possibility of earthquake prediction" in 1999.

Though the government seemed to have given up on "earthquake prediction", many researchers, even from disciplines other than seismology, have continued their research using various techniques, as they had already been convinced of the potential of the field of earthquake prediction.

One of the most promising techniques is a prediction based on electromagnetic waves. The stress underground increases well in advance of the actual earthquake, and creates earth current and electric potential. These current and electric potential then produce the electromagnetic waves in the atmosphere and change even the high ionosphere. Researchers are thus studying the potential to use this phenomenon to predict earthquakes. (See Fig. 1-1)

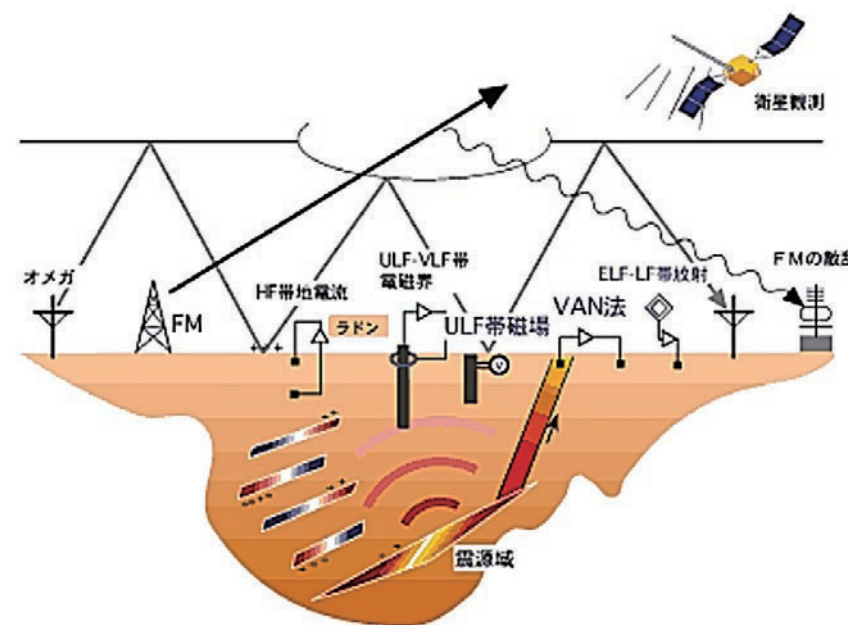

Fig. 1-1 Electro-magnetic phenomenon used for Earthquake Prediction (Home Page of Earthquake Prediction Research Center in Tokai University)

How underground structure creates earth current and electric potential

There have been many scientists that have carried out experiments on the amount of each current/potential produced by rocks pressed strongly. Fig. 1-2 shows one of those experiments conducted by Prof. Yoshida of Tokyo University in "Data from Compression Experiment of Saturated Sandstone". When pressure is applied on sandstone (diameter 40 mm, length 100 mm) saturated in water, approximately 0.1 to 0.3 V is produced right before the fracture. Prof. Yoshida also added that, when using basalt that does not contain crystal, approximately 1/10 of voltage generated using sandstone was produced due to the effect of water.

Since 100 mm produces 0.1 V, a square rock with sides measuring 10 km would produce 10 kV right before the fracture.

As the increase in pressure applied to the rock is what produces the voltage, applying a high yet constant pressure will not result in electric potential. Scientists suggest that the voltage occurs due to the gaps on molecular level called

micro cracks (destruction/deformity of microscopic molecular structure) in the stone being filled when the pressure is applied as well as the displacement of the water contained within the stone. According to this theory, it is then possible that, when all the gaps are filled and the water displaced, the voltage will no longer occur even the pressure is increased.

In fact, the amount of noise increased daily before the earthquake then decreased after the peak and eventually became almost non-existent (called data convergence). Most earthquakes then occur following the convergence due to the movement of the fault.

Therefore it shows the possibility that the magnitude of the earthquake can be estimated since the total amount of noise around the peak seems to be proportional to the size of the entire rock on which the underground pressure is applied, and that the time frame when the earthquake is likely to occur can be predicted by the convergence of data.

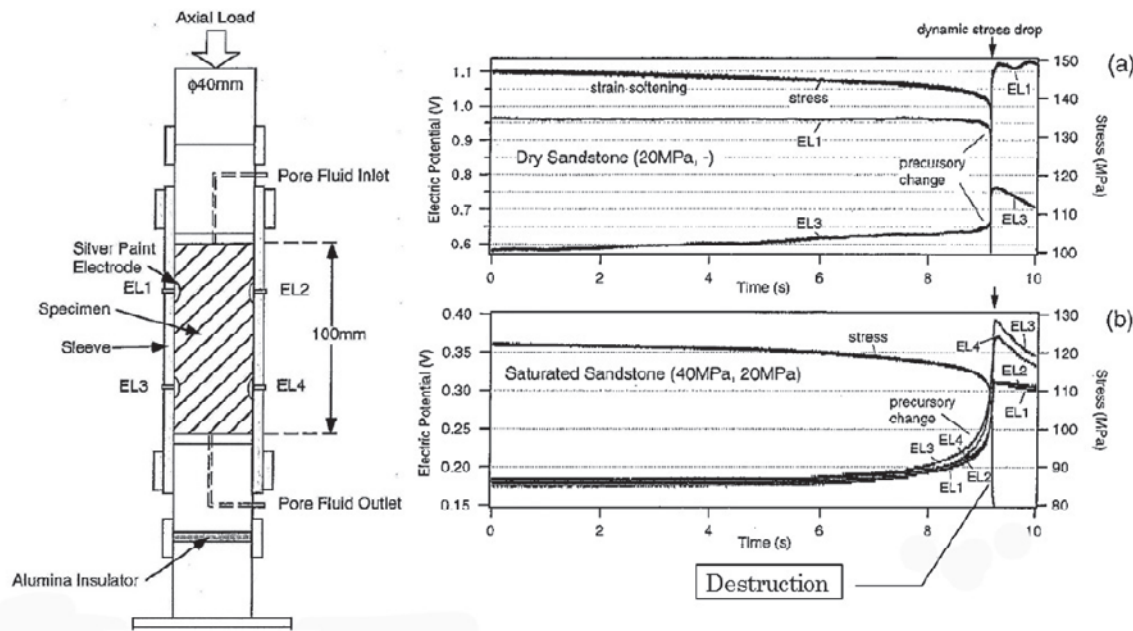

Fig. 1-2 Experiments conducted by Prof. Yoshida of Tokyo University

Reverse radio that extracting the electromagnetic radiation noise from under the ground

Many scientists, including Prof. Moriya at University of Hokkaido, Mr. Kushida in Yamanashi, and Prof. Varotsos in Greece, have been researching the "electric/electromagnetic wave approach" to earthquake prediction. One of the common hurdles among them seems to be the "erroneous detections due to man-made electric current/electromagnetic wave caused by passing trains and broadcasting or communication signal waves etc.

It can be said that virtually all frequency zones are being used for broadcasting/communication nowadays. Our company therefore turned this reality on its head and developed the "reverse radio" system (Patent Number 3188609) that presumes

the presence of the broadcasting radio signals and cancels them while extracting the electromagnetic radiation noise occurring in nature. Using this technique, we have been successful so far in predicting many earthquakes with the suggestion from Prof. Nagao of Tokai University.

Information regarding earthquake prediction is sent out weekly by "Kurukamo Group" consisting of 3 companies (*3) including ourselves, via its website and e-newsletters.

Here are several examples of our predictions over the years and the results for 2012. (We are still in the process of compiling the data for 2013 [as of Jan. 30, 2014])

Sample Earthquake Prediction Based on Data Obtained from Reverse Radio

Sample 1

Fig. 2-1 shows the prediction information posted on the "Kurukamo" website on January 24, 2012, which predicted that an earthquake of $M6.0 \pm 0.5$ will occur within a week inside the circle with a radius of 150 km in the Kanto/Tokai region.

Just as predicted, a $M5.5$ earthquake occurred in Fuji Goko in Yamanashi on January 28 (Fig. 2-2). The epicenter (the center of the source of the earthquake on the surface) is 70 km from Kofu and the scale of magnitude was calculated to be $M5.8$.

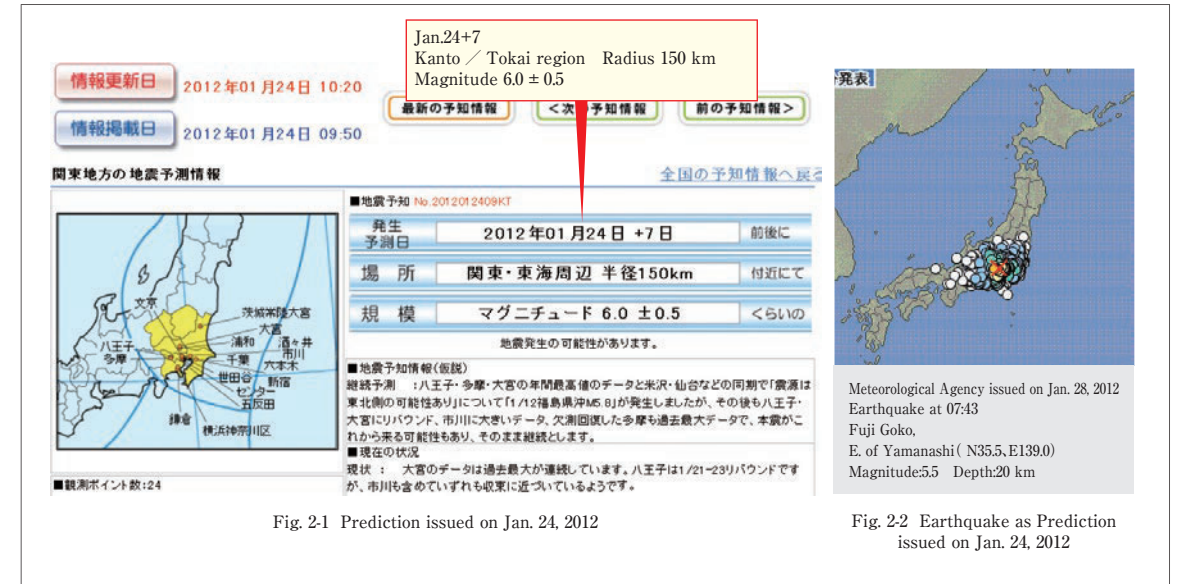

Fig. 2-1 Prediction issued on Jan. 24, 2012

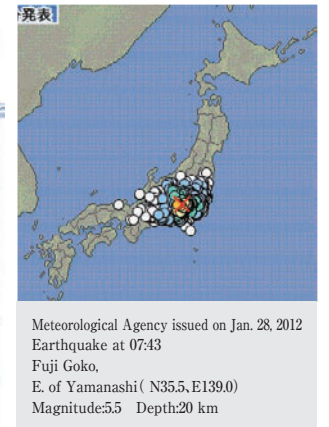

Fig. 2-2 Earthquake as Prediction issued on Jan. 24, 2012

Sample 2

Fig. 3-1 shows the screen shot of the "Kurukamo" website on April 24, 2012, which predicted that an earthquake of $M6.5 \pm 0.5$ will occur within the circle with a radius of 200 km in the Ibaragi/Chiba prefecture within a week or so starting from April 26. Furthermore, a special warning e-mail for "an imminent earthquake" was sent out to our members on April 28.

As shown below, a $M5.8$ earthquake occurred on April 29 in Northeastern Chiba as predicted. Its epicenter was 50 km from Chiba and the calculated scale of magnitude was $M6.4$. Our prediction successes have been numerous and our prediction rate exceeded 90% in 2012.

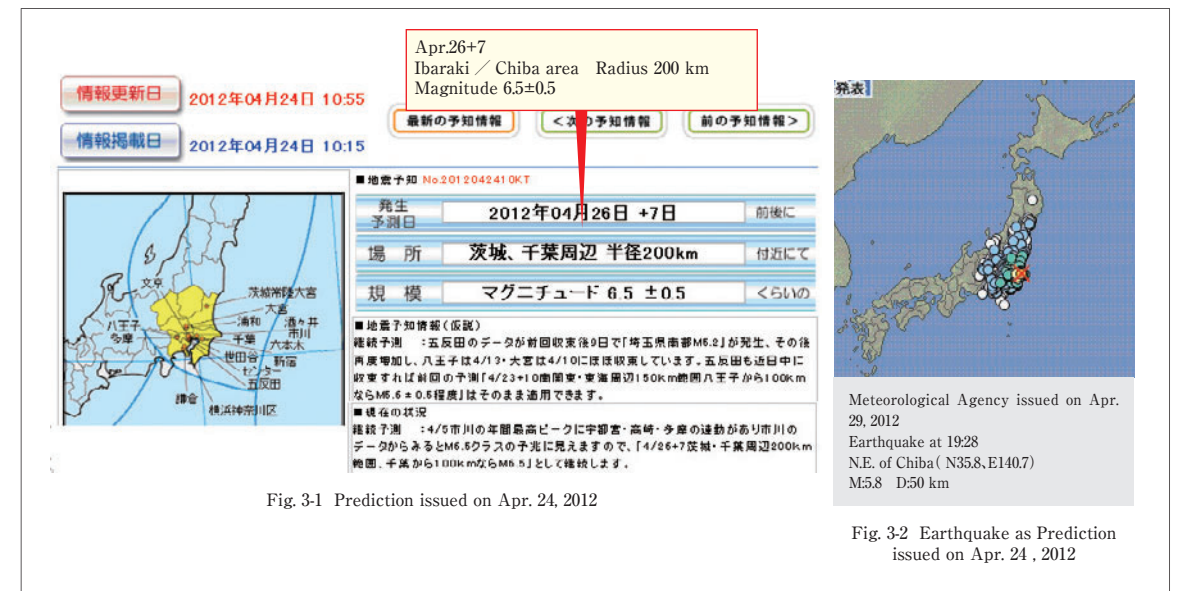

Fig. 3-1 Prediction issued on Apr. 24, 2012



Fig. 3-2 Earthquake as Prediction issued on Apr. 24, 2012

Earthquake Prediction Rate Using Data from Reverse Radio

Overview

Among 98 “earthquake prediction” issued on the website in 2012, the number of “exact matches” was 67, and 25 were “near-misses” with one erroneous element in the 3 elements of earthquake prediction, which are the date, scale, and location. We also had 6 “failed predictions” where no earthquake occurred after a prediction was announced. In other words, out of all predictions announced in 2012, 93% of them led to actual earthquakes (Table 1).

Prediction rate in 2012	Sign	Number
Number of total prediction	T	98
Number of “exact matches”	A	67
Number of “near-misses”	B	25
Number of “failed predictions”	E	6
Prediction rate (A+B/T)		93%

Table 1 About all Predictions issued for occurrence in 2012 and result

Large-scale Earthquakes

Table 2 shows data on large-scale earthquakes. There have been 26 large-scale earthquakes of M5.4 or higher whose maximum seismic intensity (Richter scale) was 4 or higher in 2012. (There were 2 other large-scale earthquakes outside our prediction areas, making the total 28.) Of those 26 earthquakes, 9 have been eliminated, as they were aftershocks that do not produce precursors as electromagnetic radiation noise. Of 15 earthquakes, 10 have been “exact matches” while 5 were considered to be “near-misses”. None of them was a “surprise earthquake” with no prior warning nor was there any “failed prediction”. We can therefore say, based on these results, that we had “almost 100%” success rate in 2012 when it came to predicting large-scale earthquakes. There also have been 9 “aftershock-based predictions” to warn of “possible seismic activity”. These predictions were based not on the data on electromagnetic radiation noise but rather on the trend of occurrence of aftershock earthquakes. We also had 2 missed aftershocks meaning no action was taken as “aftershock-based prediction”. Our prediction rate, when including these “aftershock-based predictions”, is 92% (24 out of 26 earthquakes).

Prediction rate in 2012 (Large scale earthquakes)	Sign	M5.4 or higher Seismic intensity 4 or higher
Number of total prediction (w.o. 2 out of area)	T	26
Number of earthquakes w. o. aftershocks	S	15
Number of “exact matches”	A	10
Number of “near-misses”	B	5
Number of aftershocks	Y	11
Number of “aftershock-based predictions”	C	9
Number of missed aftershocks	E	2
Prediction rate including aftershocks (A+B+C)/T		92%

Table 2 Predictions issued for Large scale earthquakes in 2012 and result (M5.4 or higher Seismic intensity 4 or higher)

Note: Aftershocks

Aftershocks are the “leftover release” of the underground distortion, the majority of which is “released by the main earthquake”. The distortion of underground structure accumulates over a long period of time while producing electromagnetic radiation noise before earthquake. Because of almost no increase of underground distortion before aftershocks, there is only a very small amount of electromagnetic radiation noise as precursor. If, however, another underground distortion accumulates anew, electromagnetic radiation noise will be produced, which will allow for a prediction based on data graphs. According to the observation record by Prof. Moriya, formerly of Hokkaido University, “On September 26, 2003, scattered waves were detected over FM stations prior to the Tokachi Offshore Earthquake (M8.0); however, there was only very slight scattered waves before other large-scale aftershocks of the said earthquake.” (p.95 of “Era of Earthquake Prediction” by Takeo Moriya. *4)

As shown above, this system has demonstrated a very high level of accuracy, which has been greatly appreciated by our several thousand members.

It is natural to think that this type of information should be shared with as many people as possible. However, unrestricted publication can cause misinformation, which then can result in damage to the predicted region. The “Kurukamo Group” therefore disseminates its prediction information only to fee-paying members who signed a contract stipulating that she or he will not freely share the information with others.

Now, the structure of observation system “Reverse Radio (Patent Number 3188609)” used for generating our prediction information is explained in the following section.

Earthquake Prediction at Home : Observation System for Electromagnetic Radiation Noise Occurring in Nature Using Reverse Radio

Below is the standard device for reverse radio observation.

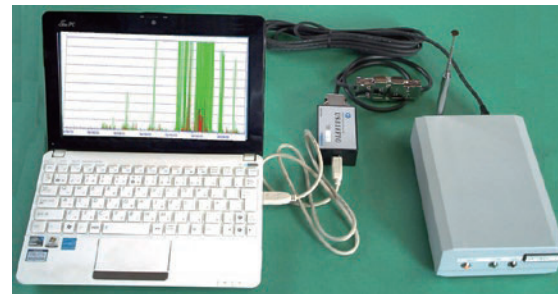

Pict. 1 Observation device (1) using Reverse Radio and PC

The lunchbox-size box on the right is the “reverse radio” whose formal name is “Electromagnetic Radiation Noise Detector/Analyzer”. This device contains a circuit that can automatically

cancel man-made signals such as broadcasting/communication signals and allows for the detection of noise waves occurring in nature. (See later sections for the detailed description of this technology.) The data detected by the reverse radio are sent to the computer via the small interface box connected to the USB port. A long

cable is provided in order to keep the reverse radio away from the computer to prevent any interference by the computer noise.

The computer sends out the counted data daily to the Prediction Information Center via an automatically generated e-mail.

The below is a system that does not include a personal computer.

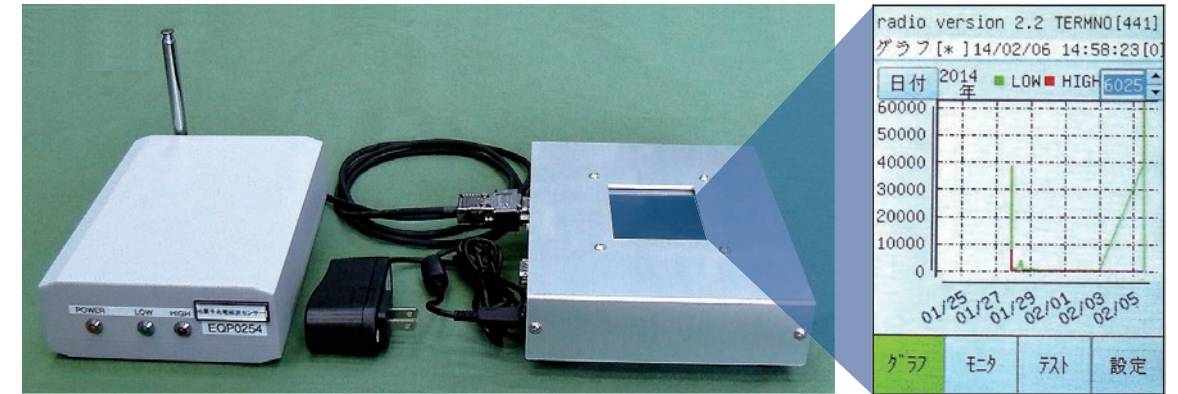

Pict. 2a Observation device (2) using Reverse Radio and PC-Less Controller
Pict. 2b Example of Display in the front panel of PC-Less Controller

The controller on the right receives and records the noise data sent by the reverse radio on the left. The data are then sent out once or twice a day via an automatically generated e-mail to the Prediction Information Center. One of the advantages of this system is that, when a blackout of power source occurs, it is automatically restored as soon as the power source is restored, which is especially useful for unmanned observation points.

The data graph is always displayed on the screen at the center of front panel (Pict. 2b), however, if a computer is connected to the same LAN, graphs and data can also be viewed on the computer as shown in Fig. 4. In other words, the data and graphs can be viewed in an office at any time even if the observation system is installed settled on the other floor or elsewhere.

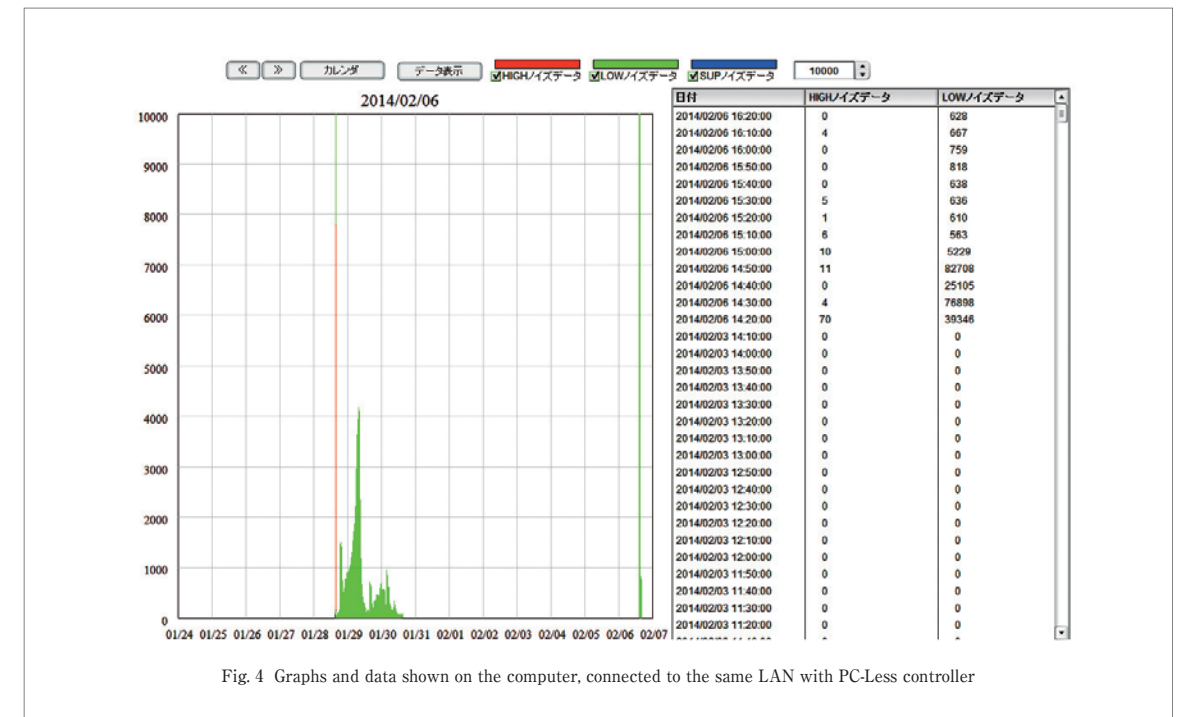

Fig. 4 Graphs and data shown on the computer, connected to the same LAN with PC-Less controller

Earthquake Prediction at Home

Earthquake prediction can be learned by observing the screen of the reverse radio daily.

For example, Fig. 4-1 shows that the noise data that are usually very low increased significantly day by day and exceeded the maximum value of the graph continuously for more than

24 hours then returned back to its normal level (called data convergence). This phenomenon can almost guarantee an earthquake within a few days. The seismic intensity of the earthquake is proportional to the total size of the graph.

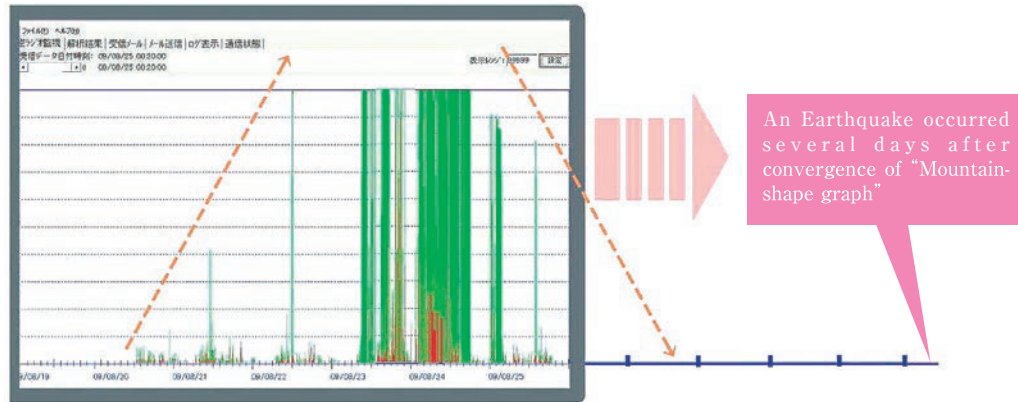

Fig. 5-1 Example of graph showing precursor of earthquake

Furthermore, “Kurukamo Earthquake Prediction Information Center” automatically receives daily reverse radio observation data from 80 sites in Japan (Fig. 5-2) as well as 3 sites overseas. The data collected are then studied and analyzed at the headquarters then compiled as our weekly “Earthquake Prediction Information” posted on our website. Members also receive prediction information via e-mail.

Observation point managers in charge of the reverse radio observation device can freely view the data and graphs from their own observation device as well as view/read data graphs generated by other observation points and all the prediction information posted on the website, which allow them to be prepared should an earthquake be imminent.

Out of our 80 observation points, Prof. Nago, the head of Tokai University Earthquake Prediction Research Center, manages the Shimizu/Tokai University observation point while Associate Prof. Yamanaka of Osaka University manages the Toyonaka observation point.

What’s more, Prof. Katsunori Fukui, who was at the time an assistant professor at Tokyo University, was awarded Excellence in Thesis Award (*5) by Japan Society of Civil Engineers for his research on earthquake prediction using reverse radio. He currently manages the Bunkyo observation point at Tokyo University where he continues his research.

Also, Japan Conservation Engineers Co. Ltd., has so far set up 7 reverse radio observation points nation-wide.

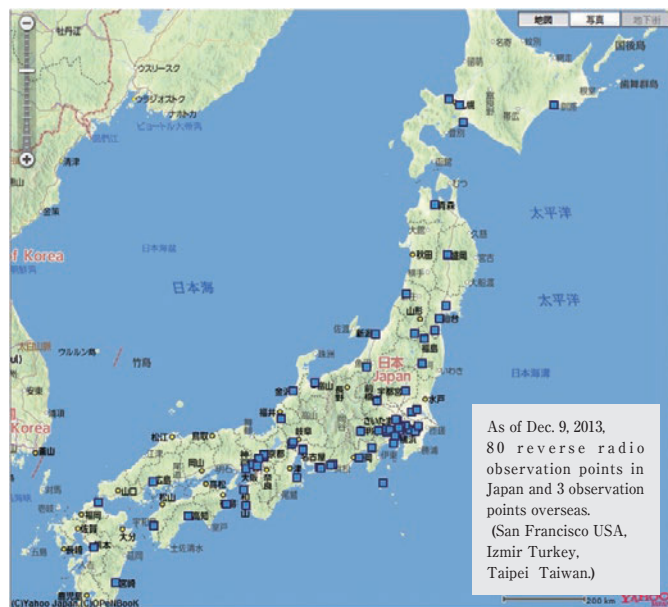

Fig. 5-2 80 observation points all over Japan

Using Abnormal Data Detection as the Method for Earthquake Prediction

The principle of the above-mentioned earthquake prediction is to “detect abnormal data”. The electromagnetic radiation noise data obtained by using the reverse radio installed at each station nation-wide are automatically sent to two Earthquake Prediction Centers including our own.

At the center, we then thoroughly verify the enormous amount of data received and evaluate which observation point(s) detected “abnormal data that significantly exceed the norm” in order to determine where an earthquake is likely to occur. However, in most cases, earthquake doesn’t occur while

abnormal data is appearing continuously.

Generally, after the abnormal data reached the peak, the data decrease and return to the normal level (called “data convergence”). In many cases an earthquake occurs a few days after the data convergence.

Table 3 explains the principle of earthquake prediction based on “the appearance of the data” and the “types of convergences”.

To be sure, the natural world deep inside the earth cannot be expected to behave in a set, consistent way. We believe, however, that it is possible to predict an earthquake with a certain level of accuracy if the graphs, shown in an observation point as well as shown on the website, are carefully examined referring to Table 3, along with the investigation of the relationship between those graphs and the actual earthquakes.

Abnormally massive data of electromagnetic noises could be the precursor of an earthquake. Prediction differs by appearance and convergence of the data.	
Amount of detected data increased suddenly to make a pole and converged in short time (single pole)	Possibility of earthquake occurrence within 2 weeks
Amount of detected data increased suddenly and converged after several hour (wide pole)	Possibility of earthquake occurrence within 2 weeks
Amount of detected data increased day by day and decreased and converged (mountain shape)	Possibility of earthquake occurrence within several days
Big amount of detected data at several observation points simultaneously (mountain or pole shape)	Possibility of big earthquake occurrence about 10 days after convergence
The most of big amount of detected data show green graphs	Possibility of big earthquake occurrence at far from the observation point
The most of big amount of detected data show red graphs	Possibility of big earthquake occurrence at nearer place after convergence

Table 3 Prediction according to appearance and convergence of the electro-magnetic noise data.

We have also discovered in recent years, while examining the data detected at the same observation points, that “the amount of data are very closely related to the size of the earthquake”. It should be noted, however, that the above-mentioned “size of an earthquake (in magnitude)” signifies the “converted value at 100 km from the observation point” calculated based on the actual magnitude.

For example, let us assume that a M3.0 earthquake occurred as shown in Fig. 5-3. Since the Toyohashi observation point is located approximately 100 km away from the epicenter, M3.0 can be used as the basis of our calculation, which means that the data obtained can be used for examination/analysis without having to be converted. The Shimizu observation point, on the other hand, is located approximately 30 km away from the epicenter; the magnitude estimate is therefore calculated by

adding 0.6, which means that we assume that an earthquake of M3.6 100 km away from the epicenter. (The value may vary depending on the depth of the hypocenter also.)

In other words, the data can be expected to be similar to those that we would have obtained from an earthquake of M3.6 that occurred 100 km away from the Shimizu observation point.

The actual calculation is naturally much more complicated than this simple “inverse proportion to the square of the distance”, rather, it is a unique formula that calculates the magnitude while taking into consideration the breadth of the origin of the electromagnetic radiation noise.

The accumulated materials regarding the correlation between the converted magnitude values based on 100 km and the data we have collected is an invaluable asset for earthquake prediction.



Fig. 5-3 An example of “converted value of Magnitude at 100 km from the observation point”

The materials are useful to examine the accuracy of prediction using data graphs.

Next, we will explain the process of earthquake prediction using easy-to-understand case studies.

Case Study of Earthquake Prediction

Single-Pole Pattern

The following example shows a relatively recent prediction information page posted on our website on December 26, 2013.

関東地方の地震予測情報		情報掲載日: 2013/12/26 10:49
予知番号	No.2013122610KT	
予測日	(2013年12月30日+14日)前後に	Dec.30+14
場所	(千葉県周辺半径100km)付近にて	Chiba region Radius 100 km
規模	(観測点から100kmの場合を標準) (マグニチュード5.4±0.5)程度	Magnitude5.4±0.5
地震予知情報	新規予測: 12/26千葉県観測点に年間最大の本立ちが 出ました。 千葉県々井、市川、五反田などの観測点も現れます。 12/30+14千葉県周辺100km範囲、観測点から100kmならM5.4±0.5程度とします。	

Fig. 6-1 Prediction issued on Dec. 26, 2013

The website also showed the following graphs based on the data provided by observation points in various locations including Inashiki in Ibaragi and Chiba.

Both graphs demonstrated that a pole significantly higher than usual ("single-pole pattern") around December 23.

Though the scale of the graph may vary depending on the location of the observation point as well as the maximum measurement, the tallest pole on the graph for the Chiba observation point was the largest of the entire year.

Other graphs, not shown here, at locations such as Shisui and Ichikawa also seemed to show the same data trend.

It was therefore decided that the epicenter of this earthquake would probably be located within 100 km of Chiba where

the highest measurement was recorded. Based on the measurements and the size of other earthquakes that occurred afterward, the magnitude of this earthquake was anticipated to be around M5.4 if it occurred 100 km away from the Chiba observation point.

The earthquake was predicted to occur "within 2 weeks of December 30" as most earthquakes occur within 2 weeks ± 1 week of the single pole.

It should be noted that the prediction of the magnitude (M) of the earthquake is based on a location 100 km away from the observation point as mentioned before.

Even a small earthquake can produce large-scale prediction data if it occurs near an observation point. By the same token, a large earthquake can produce smaller prediction data if it occurs far away from an observation point. The standard of placing the "epicenter 100 km away from the observation point" is therefore necessary.

To be sure, the relationship between the distance and the magnitude cannot be calculated so simply as the electromagnetic radiation noise as precursor may originate not only from the epicenter. Our current formula, however, is based on the principle that "the amount of electromagnetic radiation noise is inverse proportional with the square of the distance between the epicenter and the observation point" in order to calculate the magnitude used for our prediction. (See the earlier section for the formula for calculating the size of the actual earthquake that has occurred.)

The above example predicted "M5.4±0.5 if the epicenter is located 100 km away from the observation point", which means that the magnitude would be "approximately M5.1±0.5" if the epicenter was located 50 km away, and "approximately M5.6±0.5", if the epicenter was located 150 km away.

The following (Fig. 6-3) shows that, as predicted, an earthquake of M5.1 occurred in offshore of Chiba on January 2, 2014. As the epicenter was located 50 km away from the Chiba observation point, the magnitude was converted to M5.5 based on 100 km.

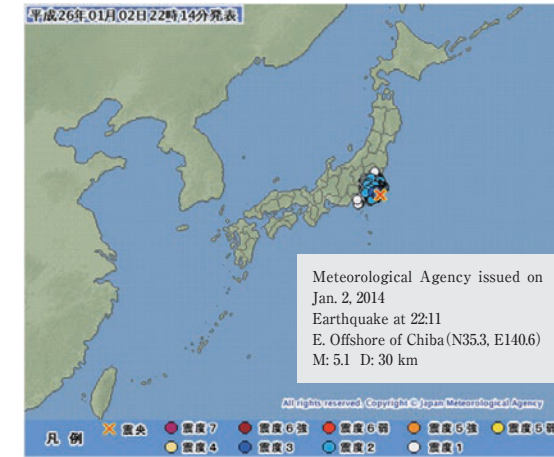

Fig. 6-3 Earthquake as Prediction issued on Dec. 26, 2013

Mountain Pattern

Fig. 7-2 shows an example using the mountain pattern.

The Sendai observation point and the Kogota observation point produced big mountains pattern graphs between September and late November of 2012.

A prediction was issued on November 27, 2012 based on the reasoning below.

Prediction Reasoning that Published on November 27, 2012

As there have been long-lasting big mountain pattern data observed at our observation points in Sendai and Kogota, we have investigated the past cases and earthquake data. For example, a "M5.7 earthquake off the coast of Miyagi Prefecture occurred on Aug. 30" after we saw 2 "wide poles" on July 10 and 23.

Compared to this example, the big mountain pattern data we have been seeing since late August seem to be more than 10 times larger. We are therefore concerned that there may be a large-scale earthquake exceeding M6 occurring after the convergence.

We are, however, unable to pinpoint the prediction time frame, as the data convergence is difficult to predict at this point and required to set a longer time period for this prediction.

We thus issued a prediction without the usual more precise time frame in consideration of the possibility that the convergence occurred earlier than we anticipated.

The prediction was "an earthquake is likely to occur within 250 km around Sendai between December 1 and 30, 2012, whose size, based on the 100 km conversion, can be estimated to be M6.1±0.5".

The following is the prediction information posted.

東北地方の地震予測情報		情報掲載日: 2012/11/28 10:16
予知番号	No.2012112809TH	
予測日	(2012年12月01日+30日)前後に	Dec.01 +30
場所	(仙台周辺半径250km)付近にて	Sendai region Radius 250 km
規模	(観測点から100kmの場合を標準) (マグニチュード6.1±0.5)程度	Magnitude 6.1±0.5
地震予知情報	新規予測: 仙台の予知データは過去に最大規模の地震データが数回続いたことにより、そのころの規模傾向が見えやすくなりました。この傾向は継続する可能性があります。今後の地震の発生が期待されますが、発生後も継続的に予測しては「中程度」です。---予測掲載 11/27 9:10---	

Fig. 7-1 Earthquake Prediction issued on Nov. 28, 2012

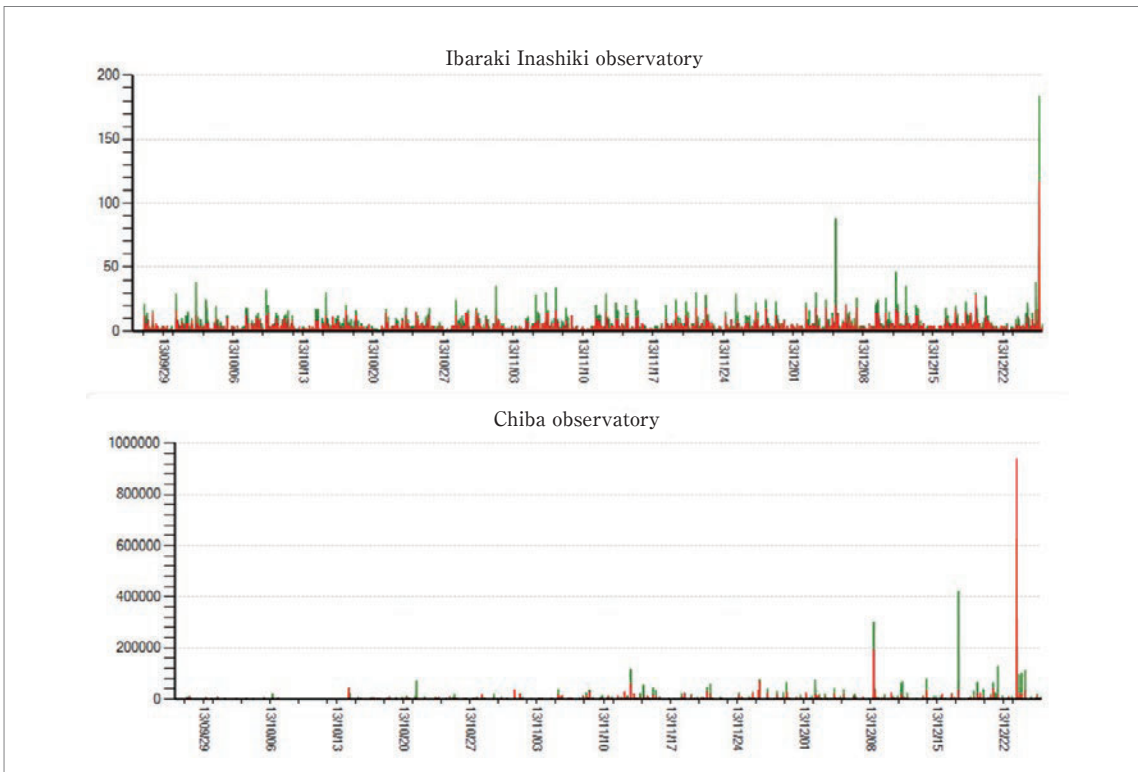

Fig. 6-2 Single pole graphs used for prediction issued on Dec. 26, 2013

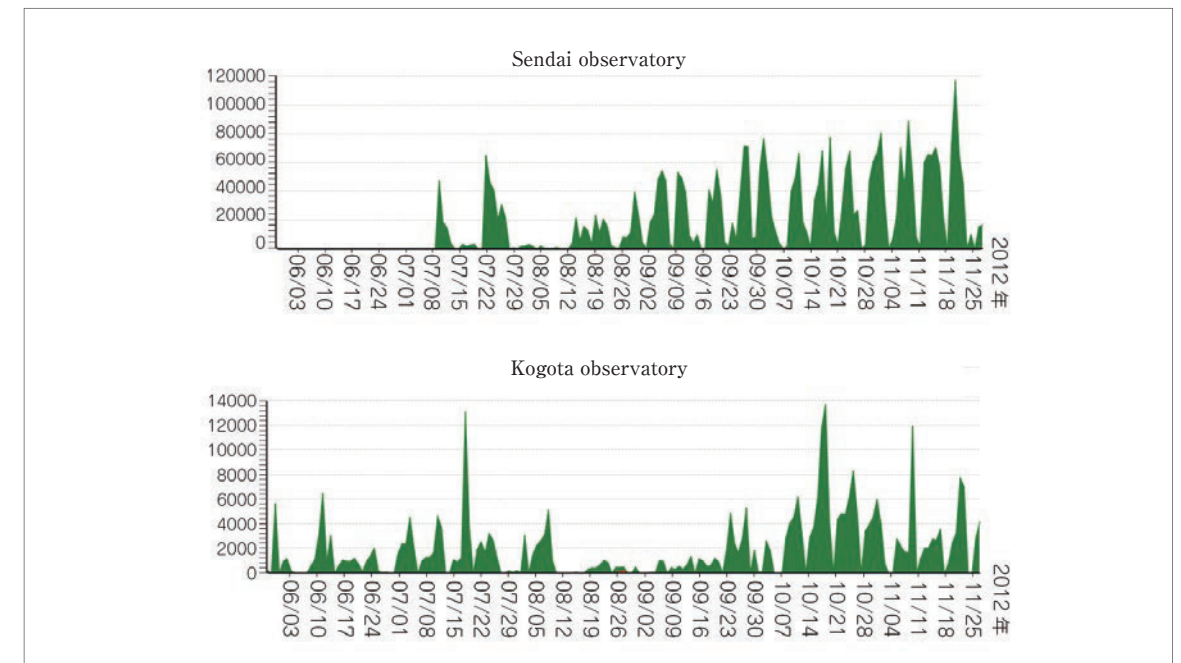

Fig. 7-2 Mountain Pattern graphs used for the prediction on Nov.28, 2012

A M7.3 earthquake occurred on December 7, 2012, whose hypocenter was off the coast of Sanriku (300 km away from the Sendai observation point). Its size based on the 100 km conversion was M6.4 (Fig. 7-3).

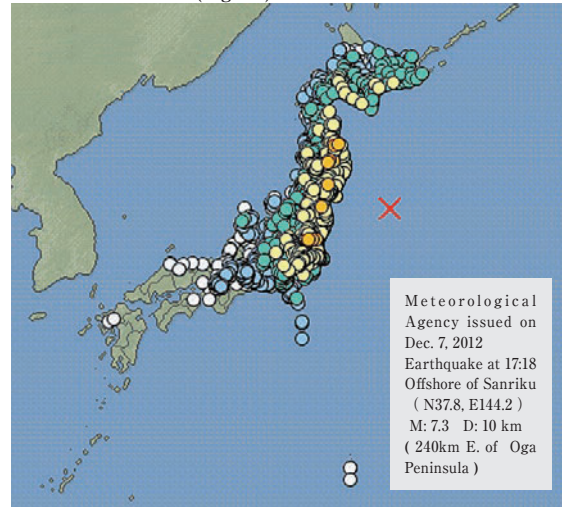

Fig. 7-3 Earthquake as Prediction issued on Nov. 28, 2012

Other Patterns

The above section provided an explanation on the prediction method using the “single-pole pattern” and the “mountain pattern”. However, other than those two, we also recognize many other patterns such as the “wide single-pole pattern”, the “double-pole pattern”, the “wide double-pole pattern”, the “wall pattern”, the “sloping mountain pattern”, and the “repeated rebound pattern”. We have developed several graphing methods to translate data into graphs in order to accurately predict earthquakes based on these patterns we see.

An ordinary graph shows the numerical data as a bar graph for every hour. We, however, make use of many other creative types of graphs such as the “daily total graph”, as well as the “comparison graph with the annual largest value”, the “ratio against the average value” graph and the “time-comparison ratio graph” that allow us to evaluate the extent of abnormality of the current data collected. Making use of the “convergence prediction” graph also allows us to predict the time frame for the data convergence when a convergence tendency is observed. Fig. 7-4 is the result of the graph in Fig. 7-2 having been processed based on the time-comparison ratio. A “mountain pattern” can be clearly seen with a pole on November 20.

Using various methods of data processing makes it easier to accurately detect “abnormal data” and helps us provide better earthquake prediction information.

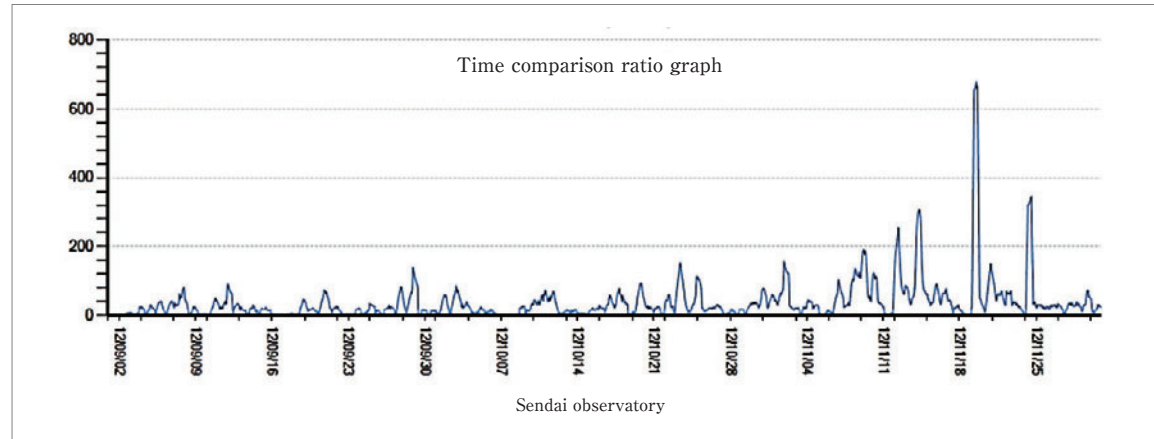

Fig. 7-4 Upper graph on Fig. 7-2 is processed based on the “time-comparison ratio”

Detection Technique of Electromagnetic Radiation Noise Occurring in Nature Using Reverse Radio

It is certain that, to be able to predict earthquakes as mentioned above, we require a technically sound method to separate and extract electromagnetic radiation noise occurring in the nature. We have so far developed 2 techniques to this end: the older basic patent (Patent Number 3188609: *6) and the newly developed patent (Patent Number 5379373: *7). The following section provides an overview of each patented method.

Function of a Reverse Radio (1)

Fig. 8 explains the function of the reverse radio and shows the phases with figures A to D.

In the AM wave band, the high-frequency carrier wave is modulated by the sound signals and broadcasted as a radio wave. (Fig. A) Pulse noise caused by the earth current may

get mixed into it. (Fig. B) This pulse noise is the precursor for predicting earthquakes, which is detected by our “Reverse Radio” (Patent Number 3188609: *6).

As shown in Fig. C, when this is received by a regular radio the sound signal after going through demodulation and low-frequency amplification makes very little audible screeching noise, even during a thunder, as this sound signal contains virtually no high-frequency pulse noise.

However, high-frequency signals would contain pulse noise after directly going through demodulation/high-frequency amplification although the envelope shape is identical to that of the sound signal.

Looking at the difference between this waveform and the sound waveform, shown in Fig. D, they cancel the majority of the waveform and clearly separate the high-frequency pulse noise, which is then counted.

We named this system “reverse radio”, as it outputs only the noise as opposed to the regular radio that cancels the noise and outputs the clear sound signal.

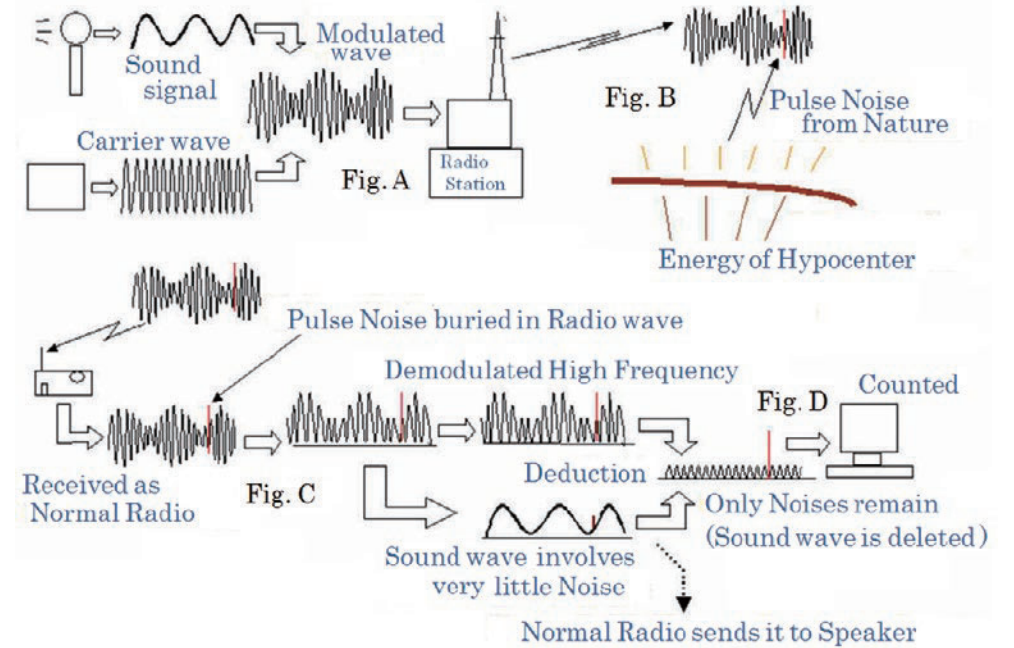

Fig. 8 Function of the reverse radio(Wave forms are for explanation only, different from real pattern)

The system targets the 850 kHz AM wave with the field intensity threshold of 52.2 dB μ V/m (lower threshold: L) and 58.3 dB μ V/m (higher threshold: H). When a high-frequency noise exceeds the threshold, it is counted as an “event” and recorded. Although a regular radio is quite capable of tuning into a frequency not being used for any broadcasting/communication purposes, foreign broadcasting frequencies may unintentionally interfere with it during nighttime. Furthermore, in this case, although a human ear can easily discriminate between sound signal and screeching noise but a device may erroneously identify all the sound signals as “noise preceding an earthquake”.

A reverse radio, even in such a case, cancels all the broadcasting/communication signals and extracts only the noise useful to us.

amplitude while those that appear in the “valley” section of the low-frequency envelope can be detected by older version circuit even if the amplitude is relatively small.

That being said, the reliability of the detection device would be limited as its detection of pulse noise depends on the timing of its appearance.

We have thus developed a noise detection method based on the reverse amplification and the phase shifting of the carrier wave and have begun to install observation devices that mainly utilize this method.

The following is an overview of its principle. It should be noted that, in the figure, Nz denotes “noise” and NzB represents the noise that occurred near either foot of wave pattern, while S and R signify “positive output” and “inverted output” respectively.

Function of a Reverse Radio (2)

The practical application of the above-mentioned reverse radio in the field of earthquake prediction has provided a multitude of earthquake prediction data and produced significant results. Furthermore, we have developed a new circuit structure to improve the accuracy of the noise detection. (Patent Number 5379373 “Apparatus for Automatically Separating and Detecting Noise Radio Wave”. Also patented in the USA, China, and Taiwan: *7)

The basic premise of this device is that it can detect the noise that has been previously undetectable by the above-mentioned older version of the reverse radio. Pulse noise gets mixed on the radio’s carrier wave at random. As shown in Fig. 9-1, if the pulse noise gets mixed near peak of the carrier wave, the noise will project outside the low-frequency envelope, which can be detected by the older version of the circuit without any difficulty. If, however, the pulse noise gets mixed to the foot of a wave pattern of the carrier wave, the older version reverse radio cannot detect it as it is hidden within the envelope. To be sure, pulse noise can be detected if it has a sufficiently large

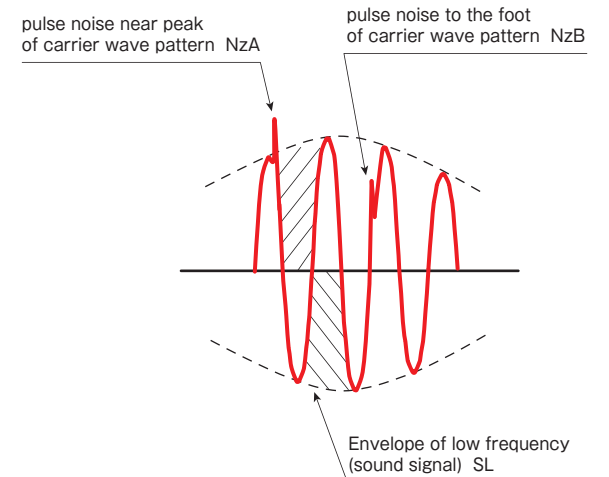

Fig.9-1 Difference of timing to get mixed pulse noises

First, similar to a regular radio, the tuning circuit "TUNE" and the amplifying circuit "AMP1" are used.

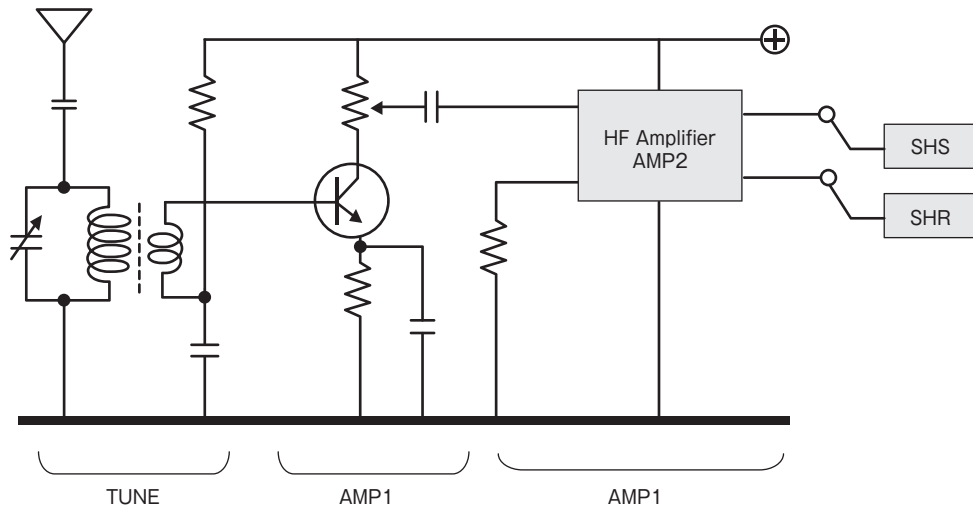

Fig. 9-2 Example of Tuning and High Frequency Amplifier

The positive output SHS of the carrier wave and the inverted output SHR of the carrier wave are then obtained through the amplifier "AMP2". (Fig. 9-2) It goes without saying that, as shown in Fig. 9-3 and 9-4, the

waveforms for SHS and SHR are inverted each other while still containing the pulse noise. pulse noise to the foot of carrier wave pattern

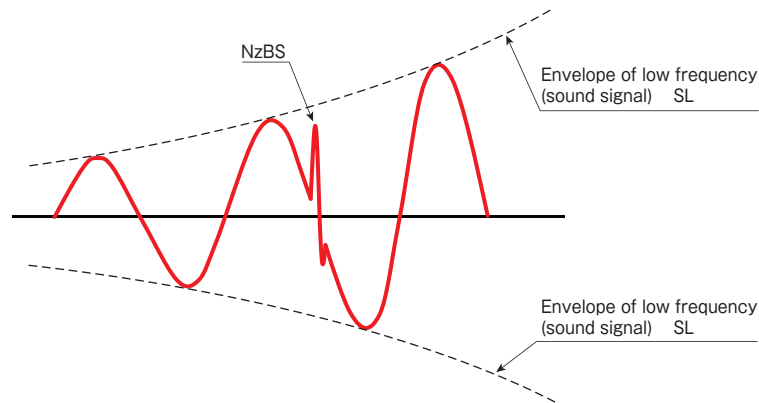

Fig. 9-3 SHS(Carrier wave with pulse noise at the foot of wave pattern)

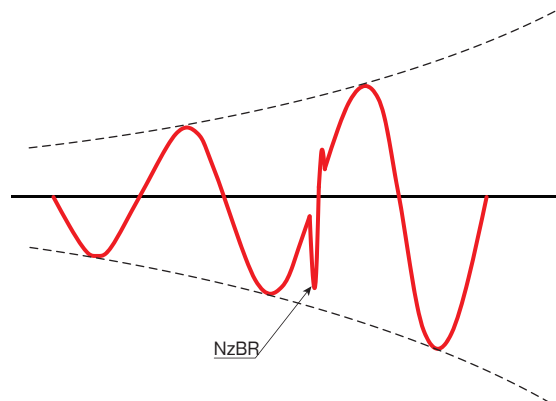

Fig. 9-4 SHR(Reversal pattern of Fig. 9-3)

There exist several methods, which are patent structural elements, to cancel the carrier wave and extract only noise using these waveforms. Although it requires rather complicated circuit process, the following section describes its general principle.

As shown in Fig. 9-5, the SHS and SHR outputs discussed previously are amplified through the amplifiers AMP3 and AMP4. Note that the amplification factor on the high-frequency side of AMP4 is kept low.

Conversely, AMP3 ensures that a normal amplification factor is maintained for the entire range as much as possible. An "all-

range amplitude adjustment circuit" is therefore also needed to be set up in order to even out the output level for both.

It should also be noted that, aside from differences in frequency characteristics, there is a significant possibility that a phase shift will also occur. A processing circuit which corrects the phase shift is therefore also required.

In the end, by equalizing the amplitude of the carrier wave for the output signal from both systems, SHS-2 and SHR-2 (Fig. 9-6 and 9-7) then adding them (SHS-2 + SHR-2), the carrier wave's waveform can essentially be eliminated (Fig. 9-8), leaving only the pulse noise.

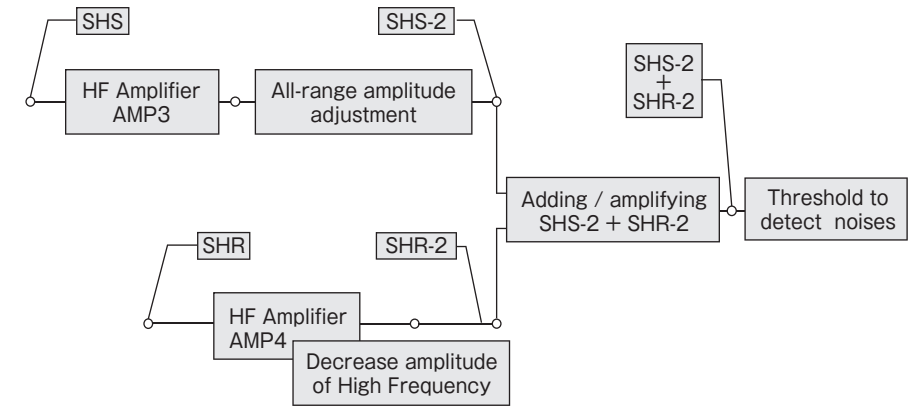

Fig. 9-5 Example of circuit to cancel carrier wave by adding reverse signals

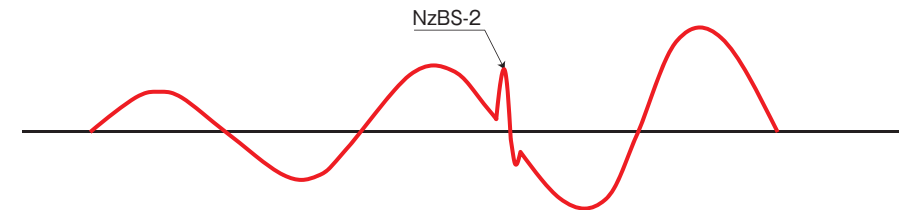

Fig. 9-6 SHS-2(Amplitude of Fig. 9-3 is reduced so much as Fig. 9-7)

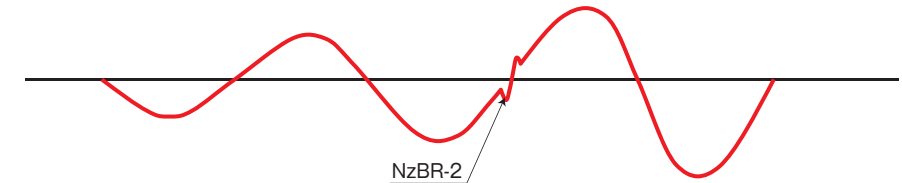

Fig. 9-7 SHR-2(Reversed pattern of Fig. 9-3 with Low-Pass characteristic)

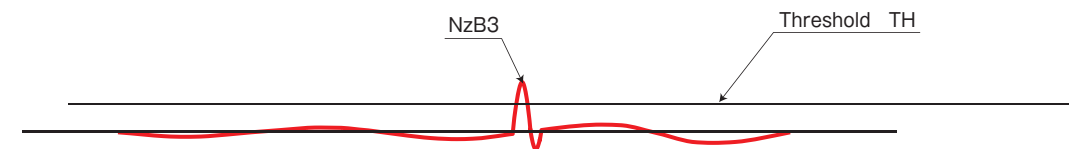
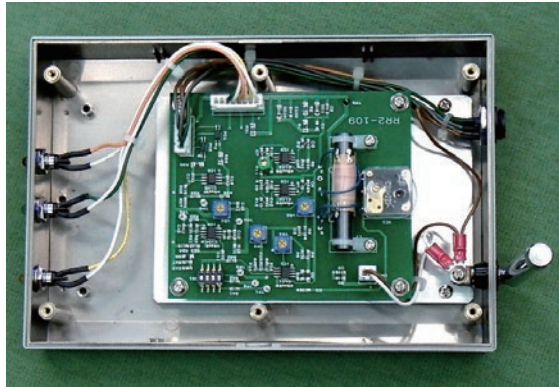

Fig. 9-8 SHR-2 + SHS-2(Addition of Fig. 9-6 and Fig. 9-7)

Lastly, TH(or the threshold) for the noise waveform is established and the number of pulse noises that exceed it is counted.

This system is similar to the "reverse radio (I)" (Fig. 8) in that it targets 850 kHz AM wave with two field intensity thresholds 52.2 dB μ V/m (lower threshold: L) and 58.3 dB μ V/m (higher threshold: H). It also has a terminal that only detects strong noise and another that can detect even weak noise.



Pict. 3 New version of the reverse radio

It should also be pointed out that this system obtained Foreign Industrial Property Application Subsidy from Tokyo Metropolitan Government, and has already been patented in the USA, China, and Taiwan. The above picture shows the internal setup of the new version of the reverse radio.

Precursor of Great East Japan Earthquake

As mentioned at the beginning of this document, "Kurukamo Group" has issued a warning before the Great East Japan Earthquake, which occurred in March 2011. The following section provides the chain of event that unfolded leading up to it. As of 2010, out of 3 observation points located in the Tohoku region, the Sendai observation point was the only one that had established a correlation between the past earthquakes and its prediction data.

One of the examples is a big data obtained in July 2010 below. The usual daily average of data at the Sendai observation point had been between 20 to 40 pulse noises; however, as illustrated in the graph below, the system recorded "two wide poles" (max. 70,000) in July 2010, which necessarily changed the scale of the graph drastically from 50 to 80,000. Following these two poles, the M6.2 "Sanriku Offshore Earthquake" occurred on August 10 as predicted.

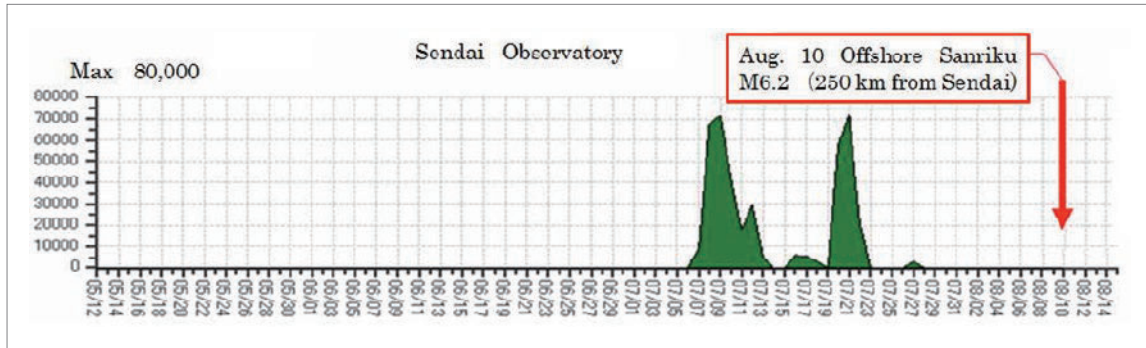

Fig. 10-1 Precursor Data of Offshore Sanriku M6.2 in Sendai observation point (Graph scale : 80,000)

The same Sendai observation point recorded data from December 2010 to January 2011 dozens of times larger than the size of the data for the M6.2 "Sanriku Offshore Earthquake" mentioned above.

Consequently, as shown below, the scale of the graph had to be

adjusted as 1 million.

On this graph, the data for the "Sanriku Offshore Earthquake" seems miniscule on the left hand side of the center. On the other hand, the maximum number of new big data on this graph was 900,000.

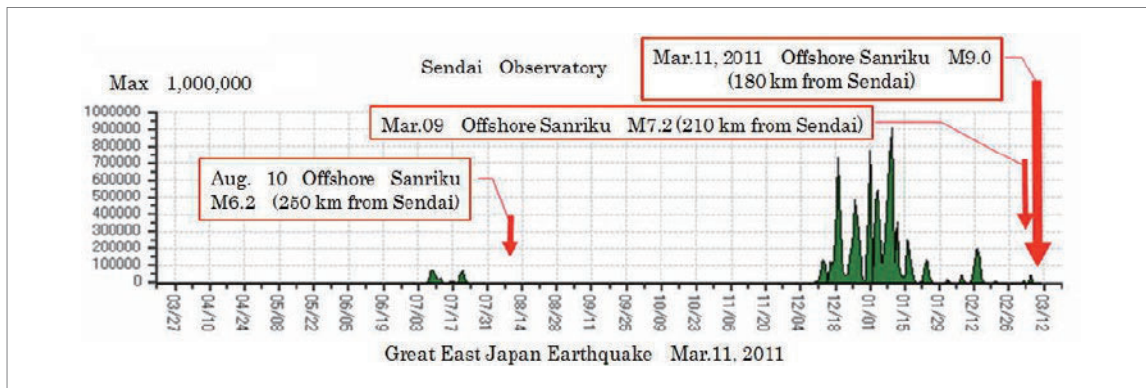

Fig. 10-2 Precursor Data of Great East Japan Earthquake M9.0 (Graph scale : 1,000,000)

This prompted us to issue a "massive earthquake warning" email to our members. The anticipated earthquake, however, did not occur for a long time.

It would have been reassuring for us if other observation points were showing a similar trend; however, there were only 3 observation points running and only Sendai observation point had solid backing of the past data, we have considered the possibility that this data may have been caused by "some kind of man-made noise at the observation point". At one point, we almost sent out an apology e-mail.

Nonetheless, an earthquake of M7.2 occurred in the Sanriku offshore on March, 9, 2011, which prompted us to prepare a statement assuming that this was the earthquake we predicted. However, the main earthquake M9.0 followed on March 11.

We have learned from this experience that a big earthquake needs long "preparation time" in underground. And other case studies that a massive earthquake may require as long as several months, after the precursor. For example, as illustrated by Fig. 8, precursor data continued for 4 months from August before "Sanriku Offshore Earthquake M7.3" occurred on Dec. 7, 2012.

We lacked experience with large-scale earthquakes before the Great East Japan Earthquake. We were also not yet entirely convinced of the reliability of our own data at the time. We still remorse if we may have missed an opportunity to save lives because we did not insist on our data and prediction with more forcefulness.

Practical Application of Prediction Information by Private Companies

As mentioned previously, the track record of our earthquake prediction has been vastly improved in recent years with many experiences including Great East Japan Earthquake. However, to utilize our earthquake prediction by governmental agencies and other public entities can still be problematic.

For example, if there was a highly accurate prediction that stated that "a M7 class earthquake will occur within one week near the coast of Tokaido", there will undoubtedly a question for the responsible person who must decide to run or stop the super express train "Shinkansen" during that one-week period. One executive at JR Tohoku says "We can make the train stop for an hour, or slow down for a half-day period, but for a week, we can do nothing".

In other words, this type of prediction information "should not be told to a governmental agency or organization" because of the problem of responsibility.

Consequently, it is up to private companies to effectively utilize the earthquake prediction information of this degree.

Suppose an insurance company installs a reverse radio at each of its branch across the country. It can then warn its clients when an earthquake is forecasted. It must be possible to reduce the amount of insurance payouts significantly if the clients move their valuables such as artwork to a safe place, or possibly save their own lives.

Other organizations and entities that can benefit from the prediction information to reduce the effect of the disaster may include transport companies, hotels, and schools and many others.

To be sure, our ultimate goal is to improve the accuracy of our information to the point where our information can be used with confidence by the government and other agencies. We will work tirelessly to increase the number of observation points, to combine and expand the reverse radio's frequency bands as well as to enhance its noise detection capability.

Network of 3000 Observation Points Nation-wide

First of all, to ensure the reliability of the data and to improve the prediction accuracy, it is crucial that we build more observation points.

"Kurukamo Group" is currently working on the project aptly named "Team 3000", whose goal is to set up 3000 observation points nation-wide, which will build a 10 km mesh network of observation points.

Having 3000 observation points each equipped with a reverse radio nation-wide will make our current prediction information almost obsolete, as anyone will be able to predict the size and the region of earthquakes by examining the graphs on the map. The date of occurrence can be deduced easily by comparing the past data.

The 80 observation points that we currently have are far from ideal. Our strategy is to increase the number of observation points/reverse radios so that observation point managers who purchased a reverse radio system can receive prediction information, access our website to view all our data, and make use of graph processing features, which are offered to our most valued members with no additional cost.

Earthquake Prediction : A Contribution to the World

Of course, Japan is not the only country that experiences frequent earthquakes. In fact, in some countries, without a strict building code geared toward earthquake resistant structure, a M6 class earthquake can cause a significant damage and loss of life.

Armed with the information obtained from a reverse radio, people can be one week ahead in evacuating dangerous buildings, which will undoubtedly save lives. It is frustrating to think that, for example, if there were 10 reverse radios in the Szechuan region in China before the major earthquake in 2013, we surely could have issued prediction information and saved lives.

The reverse radio technology has already been patented in the USA, China, and Taiwan while the application process has been ongoing in several others. What is more, we have already set up a preliminary device in California, USA, Taipei, Taiwan, and Izmir, Turkey and have been receiving data from all of them via the Internet automatically.

In fact, we were successful in predicting an earthquake in Northern California (M4.5) and another in Western Turkey (M5.0) in May 2012.

One of the major advantages of this system is that the initial investment is quite small. An observation device can be set up in any household or office in the world. One by one, they will be joining the network. The devices will automatically send data via the Internet to the Earthquake Prediction Center belonging to "Kurukamo Group" as well as our company. We firmly believe in the possibility of this system to one day, our company, become the "world earthquake prediction information center" that can make a significant contribution to the world.

Conclusion

As it was mentioned at the beginning of this document, "Kurukamo Group" including our company is still struggling to generate revenue. We feel, however, a sense of mission to serve our country as well as the world at large, and continue to operate our website and pour effort into R&D without much thought to profitability of the business. We sincerely expect many powerful support.

Trancelated from the article in "RF World No.26" by CQ Publishing Co., Tokyo Japan

About Large Scale Earthquakes in 2014 (As of Sep .1)

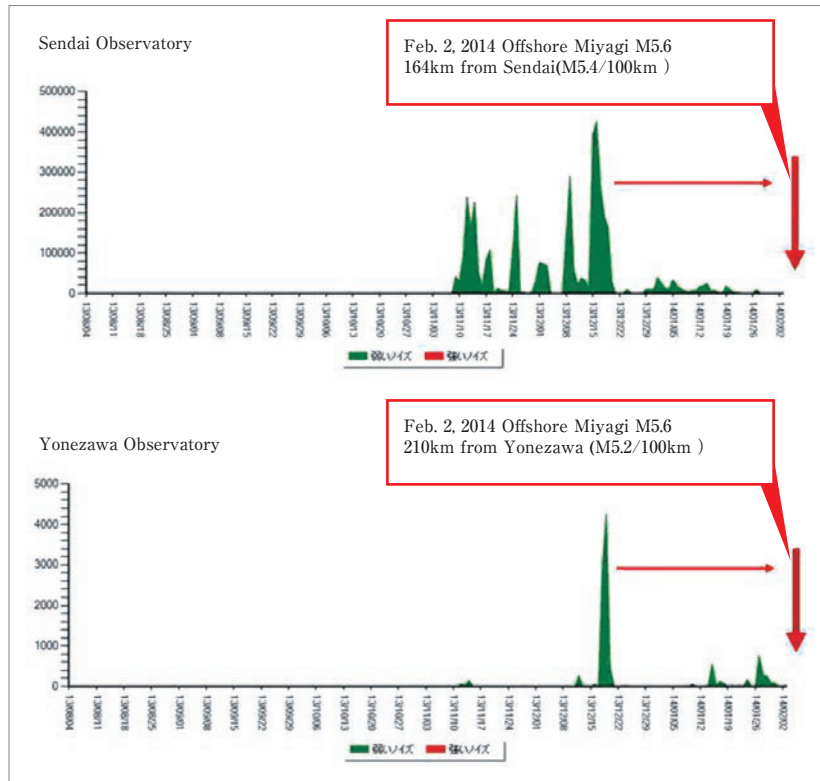

Prediction: "Feb. 5+10 250km from Sendai M6.0±0.5
Data of Yonezawa could be the precursor of same Earthquake."

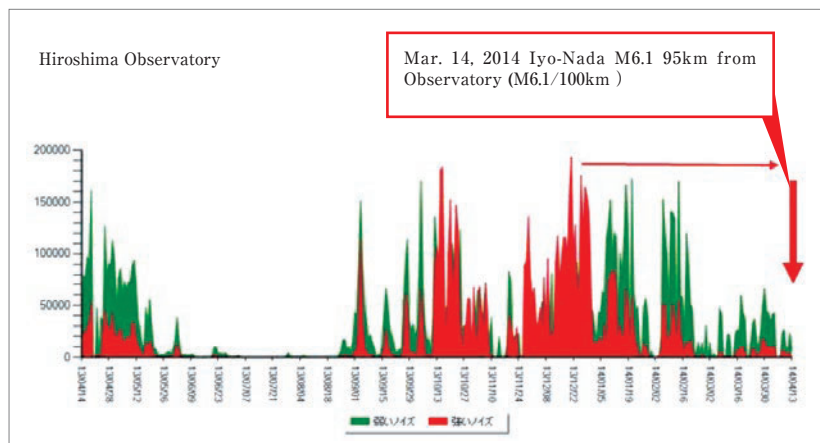

Prediction: "Mar./5+14 100km from Hiroshima M4.8±0.5"
(Result:Larger than Prediction by partial data. Total data must be the precursor)

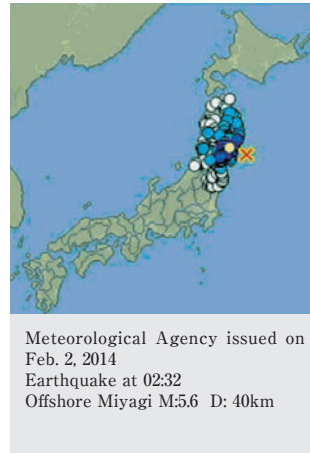

Meteorological Agency issued on Feb. 2, 2014
Earthquake at 02:32
Offshore Miyagi M:5.6 D: 40km

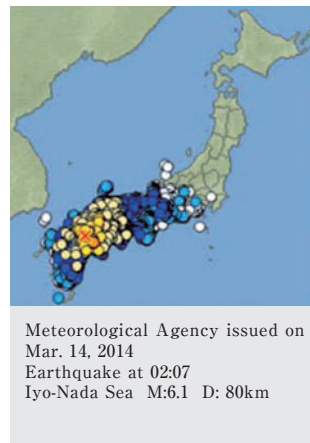

Meteorological Agency issued on Mar. 14, 2014
Earthquake at 02:07
Iyo-Nada Sea M:6.1 D: 80km

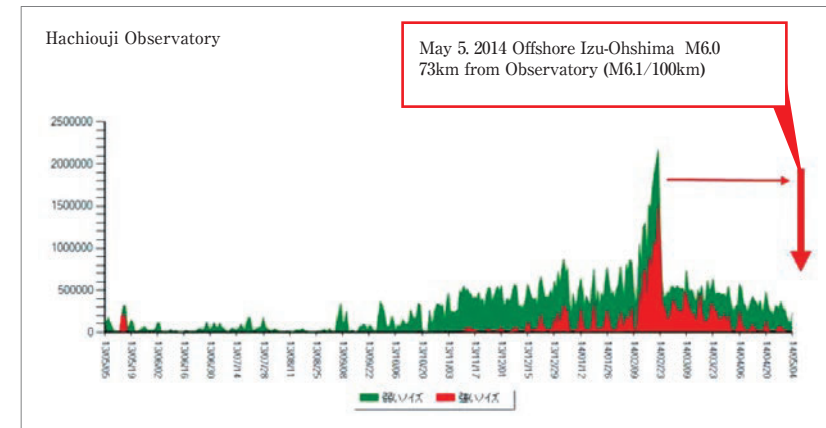

Prediction: "Aug/1+14 150km from Hachioji M5.6±0.5"

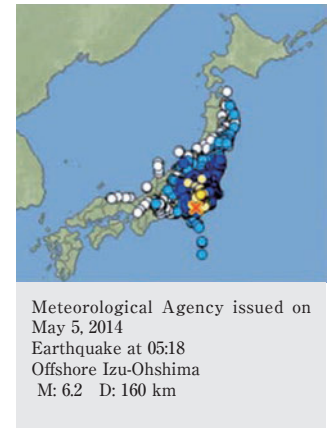

Meteorological Agency issued on May 5, 2014
Earthquake at 05:18
Offshore Izu-Oshima
M: 6.2 D: 160 km

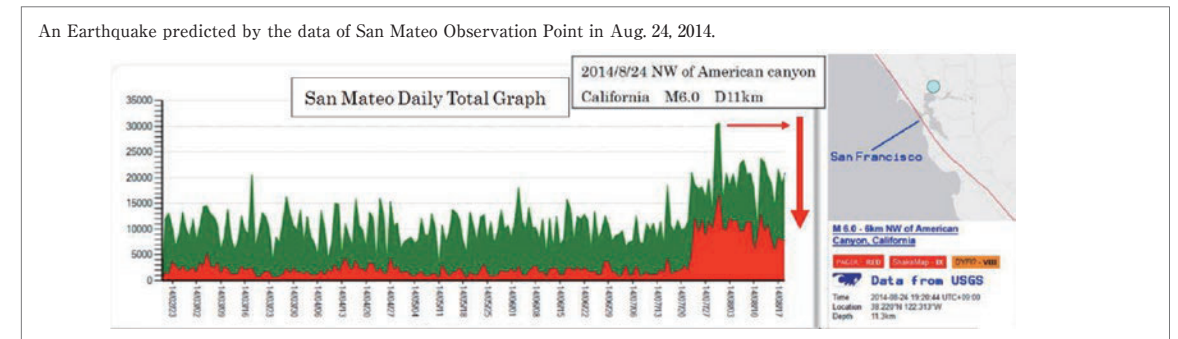

Prediction: Aug.6.2014 "Aug/13+14 Radius200km of San Mateo Magnitude4.5±0.5" (Larger then Prediction)

Reference

- *1: "Emission of Electromagnetic Radiation Preceding the Ito Seismic Swarm of 1989"
Yukio Fujinawa & Kozo Takahashi
Nature, Vol.347, No.6291, pp. 376-378, 27 September 1990
- *2: 1999/3 Essays "Comprehensive Research on Earthquake and Its Physical Process"
"Electric-potential Changes Prior to Fracture in Dry and Saturated Rocks"
Shingo Yoshida et al. 1998/10.
- *3: Kurukamo Group
Shinko Engineering Research Corporation (Setagaya, Tokyo: Product development/Data collection)
Japan Earthquake and Space System Engineers (JESSE) Co., Ltd. (Omiya, Saitama:Website and membership management)
Merisage Corporation (Nishi, Yokohama: Product (observation device) sales/Market development)
- *4: "To the Era of Earthquake Prediction: Challenge of a Radio Wave Earthquake Observers by Takeo Moriya, Seitosha
- *5: "Analysis of Abnormal Electromagnetic Phenomena Preceding Earthquake" by Tomonori Tsujimoto, Shota Matsunaga, Katsunori Fukui, and Seisuke Okubo. Essay Prize Winner, 36th Symposium on Rock Mechanics January, 2007.
- *6: Patent Number 3188609 "Apparatus for Detecting and Analyzing Electromagnetic Wave Noises"
- *7: Patent Number 5379373 "Apparatus for Automatically Separating and Detecting Noise Radio Wave"
US Patent: US8,249,516B2 2012/8/21
China Patent: ZL 2008 8 0112190.9 2012/10/3
Taiwan Patent: I 367345 2012/7/1